

Active Passive Failover Cluster

Advanced Design and Setup Guide

Perceptive Content Version: 7.0.x

Written by: Product Knowledge
Date: October 2014

perceptivesoftware
from Lexmark

© 2014 Perceptive Software. All rights reserved

Perceptive Software is a trademark of Lexmark International Technology S.A., registered in the U.S. and other countries. All other brands and product names mentioned in this document are trademarks or registered trademarks of their respective owners. No part of this publication may be reproduced, stored in a retrieval system, or transmitted in any form or by any means, electronic, mechanical, photocopying, recording, or any other media embodiments now known or hereafter to become known without the prior written permission of Lexmark.

Table of Contents

Perceptive Content on a failover cluster	4
Application interaction with the cluster	4
Basic failover requirements for Perceptive Content	5
Set up the Perceptive Content Server on a cluster	6
<i>Create the server cluster.....</i>	<i>7</i>
<i>Install Perceptive Content Server, Client, and services.....</i>	<i>8</i>
<i>What to expect from Perceptive Content Server on failover.....</i>	<i>9</i>
<i>What users can expect from Perceptive Content Client on failover</i>	<i>10</i>
Case Study 1: Perceptive Content in a Microsoft Server Cluster 2008	11
Create the server cluster	11
Install the Perceptive Content database and Perceptive Content Server	11
Configure the cluster resources	12
<i>Add the Perceptive Content resource group</i>	<i>12</i>
<i>Test the cluster resources</i>	<i>22</i>
Case Study 2: Perceptive Content in a Microsoft Cluster Server 2003	23
Create the server cluster	23
Install the Perceptive Content database and Perceptive Content Server	24
Configure the cluster resources	24
<i>Add the Perceptive Content resource group</i>	<i>24</i>
<i>Set up resources for the Perceptive Content resource group</i>	<i>26</i>
<i>Test the cluster resources</i>	<i>31</i>
Index	32

Perceptive Content on a failover cluster

This document provides guidelines on how to set up Perceptive Content in an active-passive cluster for backward compatibility.

Important To take advantage of the active-active and high-availability (HA) features in Perceptive Content 7.0, refer to the *Perceptive Content High Availability Overview Technical Guide* and the *Perceptive Content Server and Client Installation and Setup Guide*.

Perceptive Content Server is designed to be cluster-capable for every supported platform you might implement in a high availability environment. You configure and administer the failover cluster using tools provided by the operating system vendor or third-party providers. These vendors provide standard cluster-failure detection through a heartbeat connection between nodes. Examples of clustering providers include, but are not limited to:

- Microsoft's Windows Server Cluster
- IBM's High Availability Cluster Multi-Processing (HACMP)
- Sun Microsystems' Sun Cluster
- Hewlett-Packard's Serviceguard
- Symantec Corporation's Veritas Cluster Server
- Linux-HA, which is open source

A cluster configuration requires shared storage, typically a SAN, for the database and OSM storage, accessible by each node in the cluster. The hardware requirements vary by platform (server hardware, operating system, and database). For specific requirements, refer to documents provided by your hardware, operating system, or database vendor. For example, for the Microsoft Windows Server, refer to the Microsoft Cluster Hardware Compatibility List for supported configurations.

To achieve high availability, introduce as much redundancy as possible into your architecture. This includes using redundant NIC cards, switches, and power supplies. The goal is to make absolutely everything redundant so that you eliminate all single points of failure.

Application interaction with the cluster

The system runs as a cluster-unaware application. Cluster-unaware applications run the same on a cluster as they do stand-alone, letting the cluster hardware and software manage the failover. The cluster monitors the heartbeat of the system and determines whether the resources, or processes, are running. If a failure is detected, the cluster software controls the failover to a new node and launches Perceptive Content on that node.

Basic failover requirements for Perceptive Content

For Perceptive Content to gracefully failover on a cluster, two things must occur. First, your licenses must be resolved so that the proper Perceptive Content licenses are tied to the active node. Then, in the case of a failover, the services on the standby Perceptive Content Server must start. Typically, the cluster administration software provides the service control.

The following figure shows an example of how an Perceptive Content Cluster might appear on a Microsoft Windows Server Cluster. In this example, the services appear in the Name column and the name of the active node appears in the Owner column. The startup procedure for these services is based on the dependencies you set.

Name	State	Owner	Resource Type
Disk F:	Online	IN-PRIMARY	Physical Disk
ImageNow Alarm Agent	Online	IN-PRIMARY	Generic Service
ImageNow Batch Agent	Online	IN-PRIMARY	Generic Service
ImageNow Import Agent	Online	IN-PRIMARY	Generic Service
ImageNow Job Agent	Online	IN-PRIMARY	Generic Service
ImageNow Message Queuing Agent	Online	IN-PRIMARY	Generic Service
ImageNow Server	Online	IN-PRIMARY	Generic Service
ImageNow Server Switch	Online	IN-PRIMARY	Generic Application
ImageNow Virtual IP	Online	IN-PRIMARY	IP Address
ImageNow Workflow Agent	Online	IN-PRIMARY	Generic Service
IN-CLUSTER-V	Online	IN-PRIMARY	Network Name

Note The version numbers of agents do not appear in this figure and other figures in this document to show that this configuration spans multiple product versions.

Set up the Perceptive Content Server on a cluster

The general steps for setting up Perceptive Content in a clustered environment appear in the following figure. After creating the server cluster using the methods described by the cluster vendor, you can install Perceptive Content on the cluster. Environment and DBMS-specific instructions for installing the Perceptive Content database and Perceptive Content Server appear in the *Perceptive Content Server Installation Guide*.

In general, when you install the Perceptive Content Server on a cluster, you can choose to install Perceptive Content Server in a separate directory on each node or in a shared installation directory. Use this same installation choice to install any external agents that you want to run on the cluster. Part of this installation includes getting and installing the appropriate licenses for running Perceptive Content on a cluster.

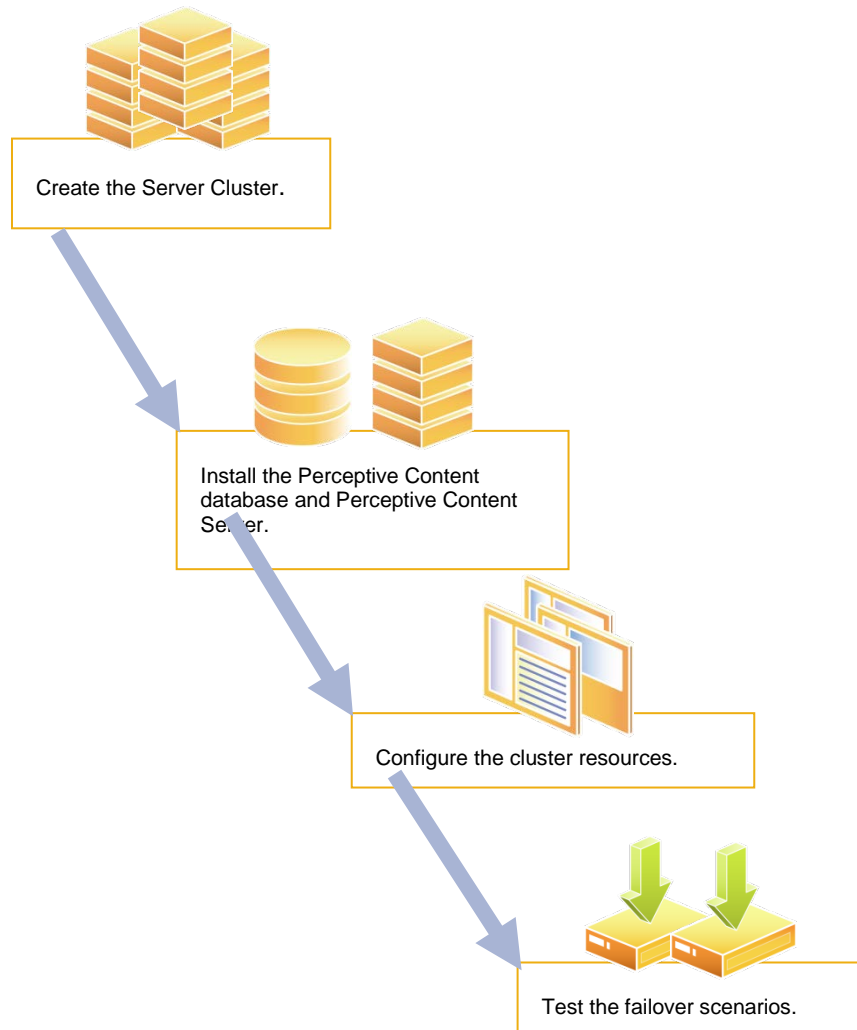

After you install Perceptive Content on both nodes, you must configure the cluster resources to set the dependencies. These dependencies declare what to launch first on failover and what resources must be running before each service can restart on the new node. For example, Perceptive Content Server must be running before any of its agents or services can start on the active node.

Create the server cluster

When designing your cluster, make sure that you follow all recommendations provided by your hardware, operating system, and cluster software vendor. These recommendations span everything from ensuring that the nodes have static IP addresses in the network to file naming limitations. For example, in Server Cluster, virtual server names must be unique and cannot exceed 15 characters.

Most cluster vendors recommend that each node have identical hardware, firmware, driver, operating system version including service packs, and software. Specifically, most cluster vendors advise that you make sure all NICs are the same make and model, with the same firmware version across all nodes. Although these are only recommendations and not requirements, the use of identical nodes makes configuration easier and eliminates potential compatibility issues.

In addition, disable any power saving features available on your server hardware, including network cards and drives. In many situations, the activation of power saving features can trigger a failover.

The following figure shows a sample cluster configuration in a Windows environment using SQL Server as the DBMS. In this diagram, the SQL Cluster comprises the nodes that store the Perceptive Content database in a cluster. The Application Cluster comprises the nodes that store the Perceptive Content Server in a cluster. In this example, the Perceptive Content database and object storage manager (OSM) are stored separately from the Perceptive Content Servers on a SAN device.

ImageNow Clustered Environment

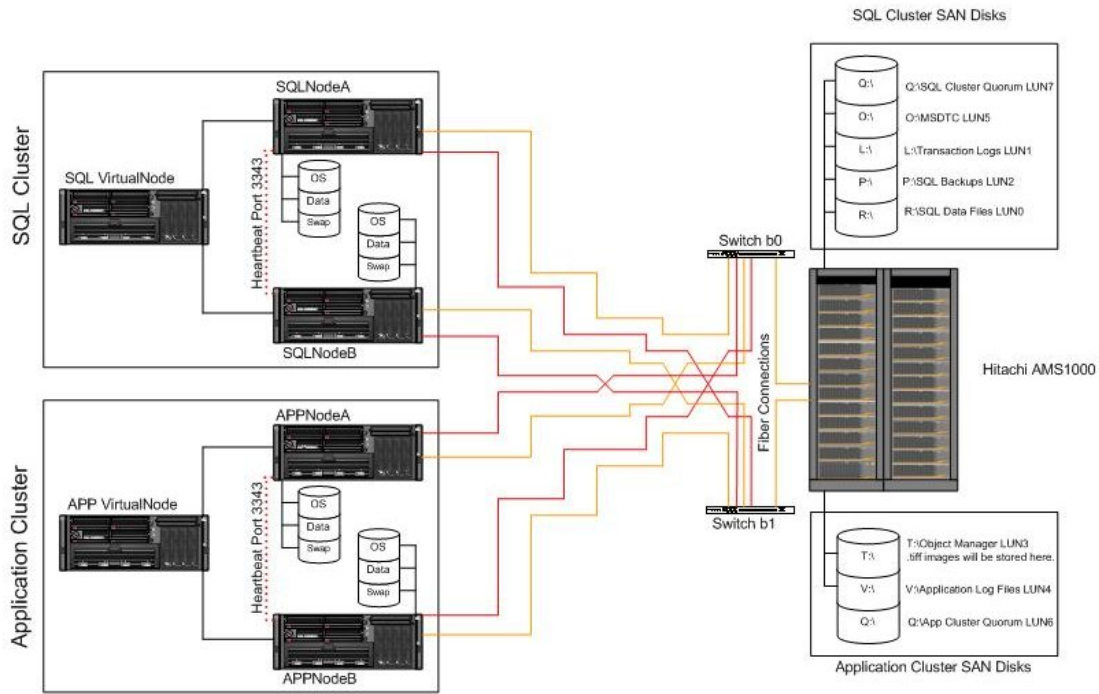

Legend

- Primary Fiber Connection
- Secondary Fiber Connection
- Cluster Heartbeat Connection

Most Perceptive Content Server external agents, such as Mail Agent, can run in an n-node configuration. In addition, any Perceptive Content agents that can be remotable (able to run on a separate server from the base Perceptive Content) can run in an n-node cluster. For a complete list of Perceptive Content agents that are remotable, refer to the Product Technical Specifications for your product version.

For security best practices, make sure the cluster is physically secure and placed behind a firewall. Do not install antivirus or antispyware on your cluster nodes, as these products can interfere with or even spawn failover. Instead, run scans remotely daily or as recommended by your company policies. We recommend that you run these scans outside of business hours to avoid any adverse effects on performance.

Install Perceptive Content Server, Client, and services

When you install Perceptive Content Server on a cluster, follow the steps provided in the *Perceptive Content Server Installation and Setup Guide* that is specific for your environment and DBMS. As this guide describes, first you install and configure the Perceptive Content database (INOW) in your DBMS. Then, you install the Perceptive Content Server in separate directories on each node or in a shared installation directory. In either case, make sure that you install any Perceptive Content agents you want to run on the cluster on the nodes in the same manner.

Install Perceptive Content Server

You can choose to install Perceptive Content Server in a separate directory on each node or in a shared installation directory. With separate installation directories, you install Perceptive Content Server on the primary nodes of the cluster, and on the fail over node. The separate directories provide you with a way to perform rolling patch level updates on separate nodes in a 24 by 7 environment.

You can also install the server software in a common directory on the shared, virtual drive that represents the cluster. This approach offers a streamlined installation approach. However, the nature of having only one installation directory lowers the ability to perform rolling patch level updates.

Install ImageNow services on a second node

After setting up Perceptive Content Server, in the **Microsoft Management Console**, open the **Services** application and review the ImageNow services that have been installed on the nodes. The nodes need to contain the same services on each node, with failover of the data disc to the standby node. For each application, agent, or service you want to include in the failover, point to [drive:]\inserver\bin*service* -i.

Install the Perceptive Content Client

In most cases, you install the Perceptive Content Client on a separate computer and access the Perceptive Content Server from the client computer via the network. In Perceptive Content Client, set up the Connection Profile to access the Perceptive Content Server using a virtual address assigned to a cluster. For example, in the following figure, IN-Cluster is the name associated with the virtual address assigned to the cluster. It does not matter which node is active if every Perceptive Content Client connects using the virtual address of the cluster. Due to the failover licensing structure, you want to run Perceptive Content on the active nodes unless a failover occurs. Refer to the "Obtain Perceptive Content licenses" section of this document for more information about limiting the time you run Perceptive Content on the standby node.

Configure the cluster resources

The process for configuring the cluster resources differs depending on your specific cluster environment. Typically, you create a single IP address and name that identifies the cluster. Then you must identify the resources and dependencies to set for starting up Perceptive Content on the cluster. The following list contains the resources to define, listed in order of dependency.

1. Add an IP address resource that represents the Perceptive Content cluster.
2. Add a network name resource that represents a computer name for the IP address.
3. Add a physical disk resource as the shared drive where the Perceptive Content and license files reside.
4. Add a generic application to switch the Perceptive Content Server to the active server.
5. Add a generic service resource as the Perceptive Content Server.
6. Add a generic service resource for each of the embedded Perceptive Content Agents (Alarm Agent, Batch Agent, Import Agent, Job Agent, Message Queuing Agent, and Workflow Agent) and any additional agents for which you have licenses.

Test the cluster resources

After you install and license the Perceptive Content system on your cluster, and configure the resources and dependencies for the cluster, you must test the failover configuration. Consider testing directed failover conditions where you specifically fail the system over from one node to the other. Then, make sure to test conditions where the failover is the result of a restart or shutdown of one node, and other types of failover scenarios.

In addition, after your cluster is set up and working, periodically test the failover to make sure that everything is in working order, and periodically review logs to make sure that the cluster is running without incident.

What to expect from Perceptive Content Server on failover

When a failover occurs, the cluster manages the failover and brings Perceptive Content back online using the dependencies defined for the cluster.

The cluster makes the standby node the active node and starts the resources, determined by a dependency list. The cluster software starts all applications on the newly active node in the order of the specified dependency. At this time, the failover license counter begins accruing, in minutes. The time spent running Perceptive Content on the standby node is recorded, for example 30 minutes, and counts toward the cumulative 90-day limit on the standby node, for example 30 minutes of a 90 day counter. Refer to “Obtaining Failover Licenses” for more information about this counter. After you resolve the issue, move the system back to the primary node.

What users can expect from Perceptive Content Client on failover

If the Perceptive Content Client user performs an action while the failover is taking place, the user might encounter the message: Connection Error occurred: Server not found. In this case, the user needs to stop work and wait until the cluster completes the failover. The user is automatically logged back into Perceptive Content after the failover.

After a failover has completed, the users accessing the Perceptive Content Server through an Perceptive Content Client are notified. In most cases, the log in dialog box flashes, and Perceptive Content automatically logs the user back in as soon as the cluster manages the failover and brings the Perceptive Content application back online. In some cases when the user is not automatically logged back in, the user may need to disconnect from the Perceptive Content Server and then reconnect to resume work.

Case Study 1: Perceptive Content in a Microsoft Server Cluster 2008

The following case study provides a specific example of setting up Perceptive Content on a Microsoft Server Cluster. This case study is based on a two-node cluster. In this cluster, when one node is active, the other node is passive.

Create the server cluster

This case study depicts the Perceptive Content Server in a two-node cluster with a quorum drive (Q:) and a shared drive (F:). In Cluster Server, the quorum drive provides a means to determine which server runs which processes and the state in which the servers and resources are in. Perceptive Content Server runs in an active/passive cluster configuration. The database runs on a separate server. When you configure the Perceptive Content Clients for the Perceptive Content Server, make sure that they point to the virtual IP address or name that you've set up to address the cluster.

The following table contains the recommended Cluster Server configuration from Microsoft. The clustering environment for this case study uses the following recommendations. For more information about these recommendations and more complete recommendations for geographically disbursed clusters, refer to the Microsoft website.

Type	Recommendations
Software	<p>Make sure the supported operating systems are identical for both nodes. Supported operating systems include:</p> <ul style="list-style-type: none"> Windows Server 2008 Datacenter Edition Windows Server 2008 Enterprise Edition
Hardware	<p>Review and follow the Microsoft Hardware Compatibility List (HCL). Recommend using identical hardware on each node.</p> <p>All nodes require at least one NIC.</p>
Network	<p>The nodes of a cluster must belong to a single domain.</p> <p>The network should support Network Name Resolution (DNS).</p> <p>The nodes of the cluster should have domain membership and static IP addresses.</p>
Shared Disks	<p>SCSI or Fiber Channel</p> <p>NTFS with more than 500 MB</p>

Install the Perceptive Content database and Perceptive Content Server

In this case study, the primary node is named img00 and the standby node is named img01. The shared drive is set to F:, and this drive is only available to the active node.

By default, Perceptive Content Server is configured to install on C:\inserver on both nodes. This example uses the F: drive on both nodes. After verifying that img00 is active, install Perceptive Content Server. During the installation, in the Destination Folder page, ensure you specify the virtual drive (F:) as the Destination directory. Then, fail over to the secondary node. Install Perceptive Content on this node, making sure that the same virtual drive (F:) is also the Destination directory. You add the `node.qualified.licenses = TRUE` setting to the `inow.ini` file in the `\inserver\etc` directory on each node.

Configure the cluster resources

In a Cluster Server, Microsoft recommends that you create a new resource group for each failover application. This section describes how to add the Perceptive Content resource group and then set up the resources for that group.

Add the Perceptive Content resource group

The following procedure describes the steps to create the new resource group. In this example, the resource group is named IN-Cluster.

Add the Perceptive Content cluster

1. Open **Failover Cluster Management**.
2. In the left pane, select **Services and Applications**.

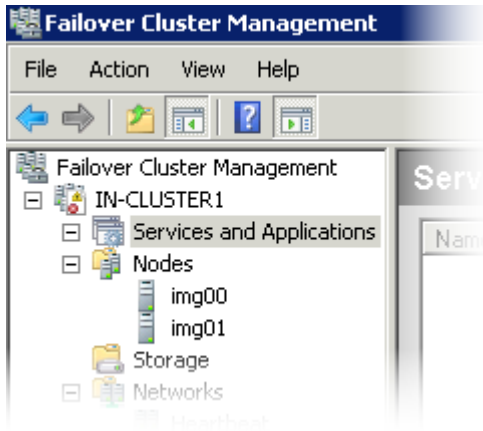

3. In the **Actions** pane, click **More Actions** and select **Create Empty Service or Application**.

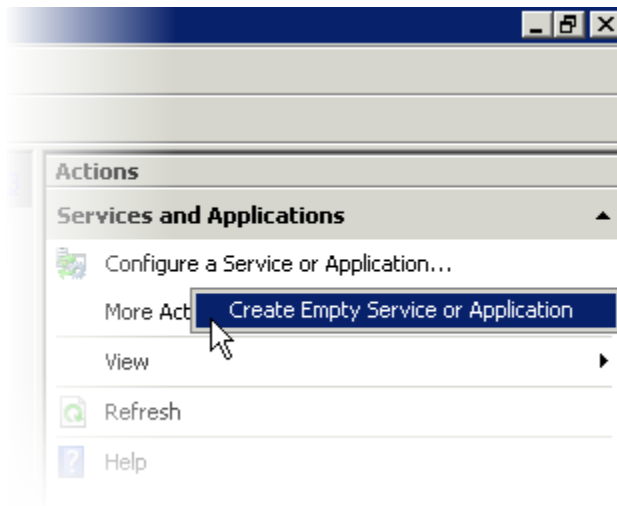

4. In the **New service or application Properties** dialog, specify the required elements and then click **OK**. In this example, the name used is IN-Cluster.

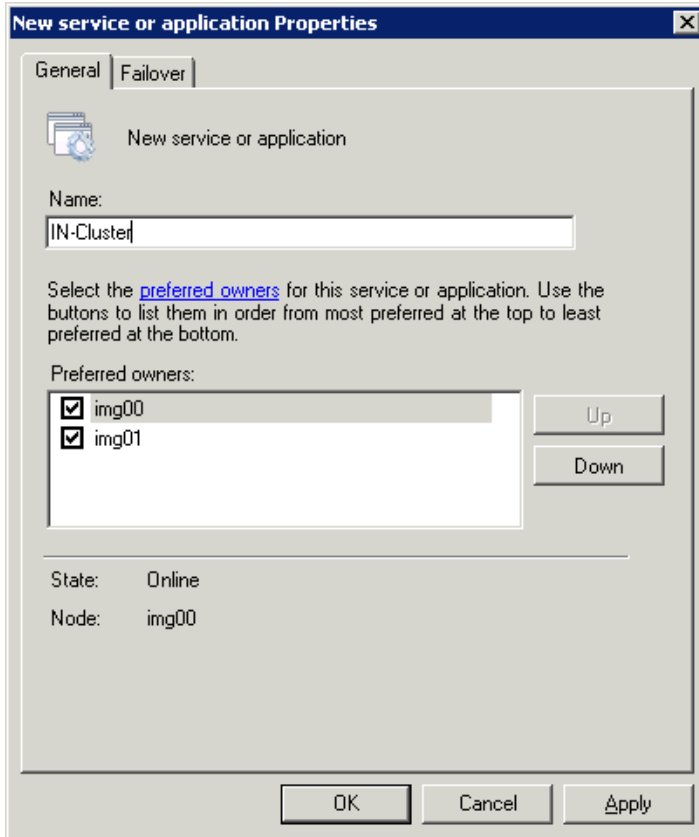

5. On the **Failover Cluster Management**, in the left pane, select the service you created.



6. In the **Actions** pane, click **Add a resource** and then select **Client Access Point**.

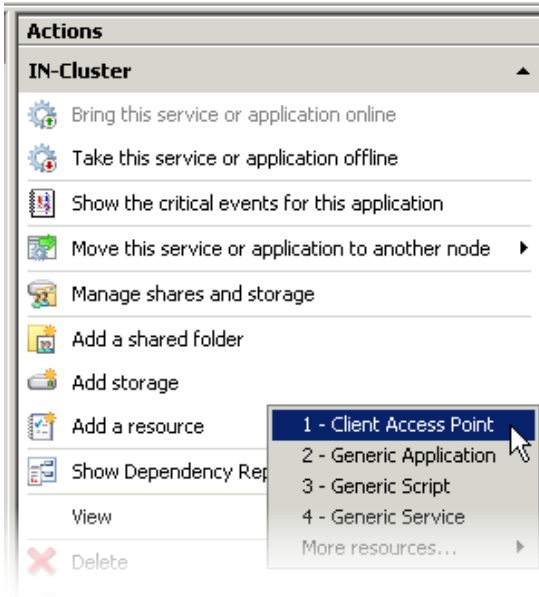

7. Enter the name of the client access point (previously known as the cluster name), click **Next** until you reach the **Confirmation** screen, and then click **Finish**.

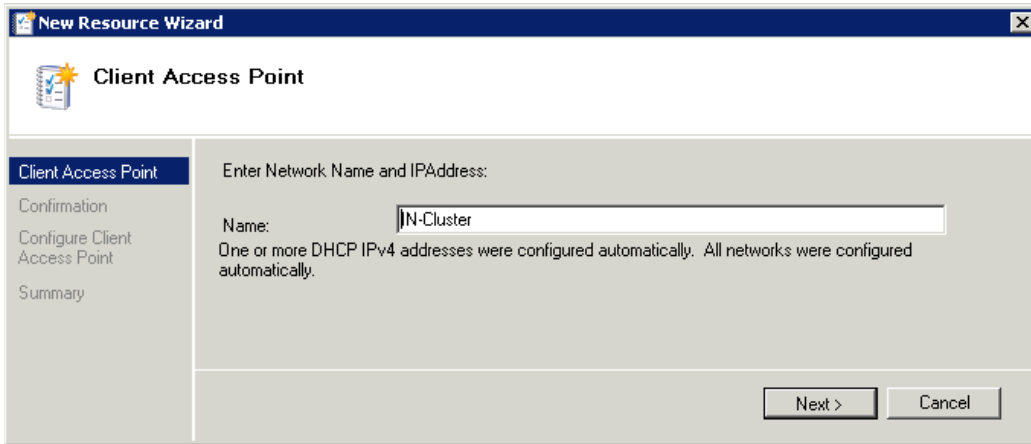

8. In the **IP Addresses** dialog, on the **General** tab, select **Static IP Address** and then specify the IP address in the **Failover Cluster Management** window.

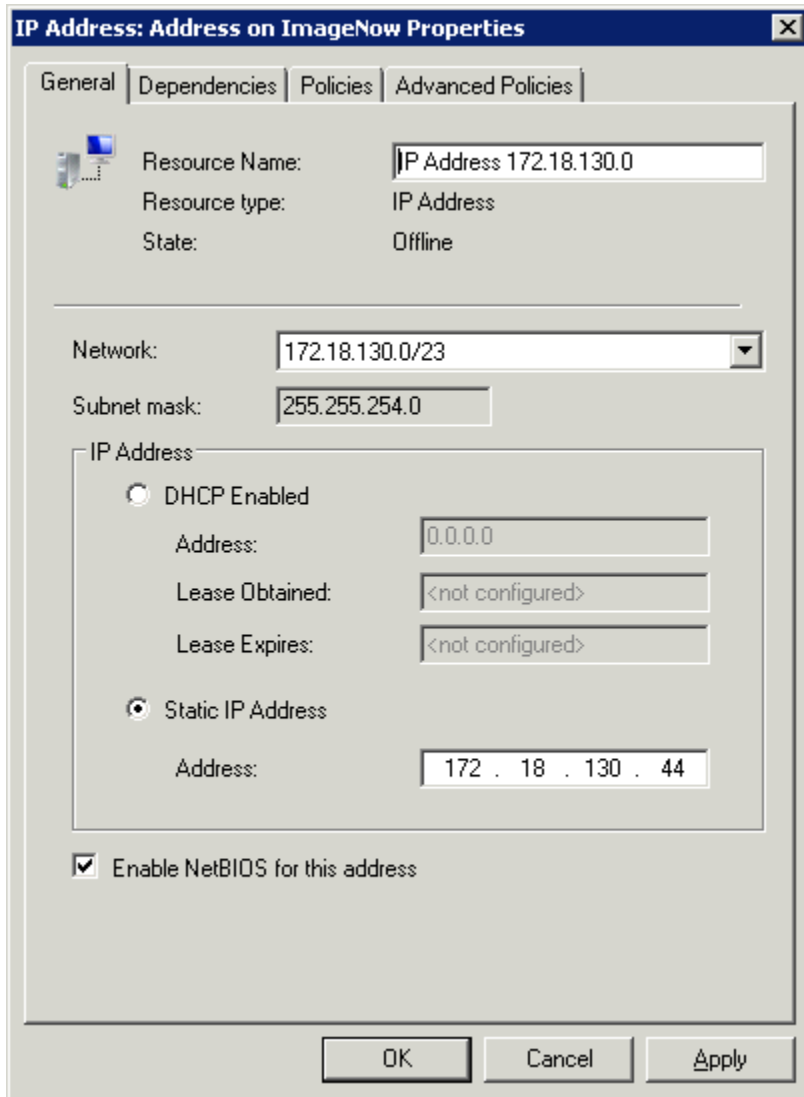

9. On the **Failover Cluster Management** window, in the **Actions** pane, click **Add storage**.

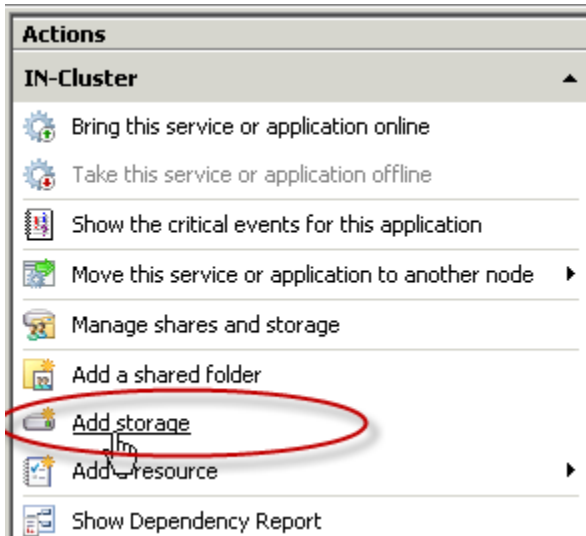

10. Select the shared drive that contains the ImageNow services files. This is usually the same location where INServer is installed. Click **OK**.

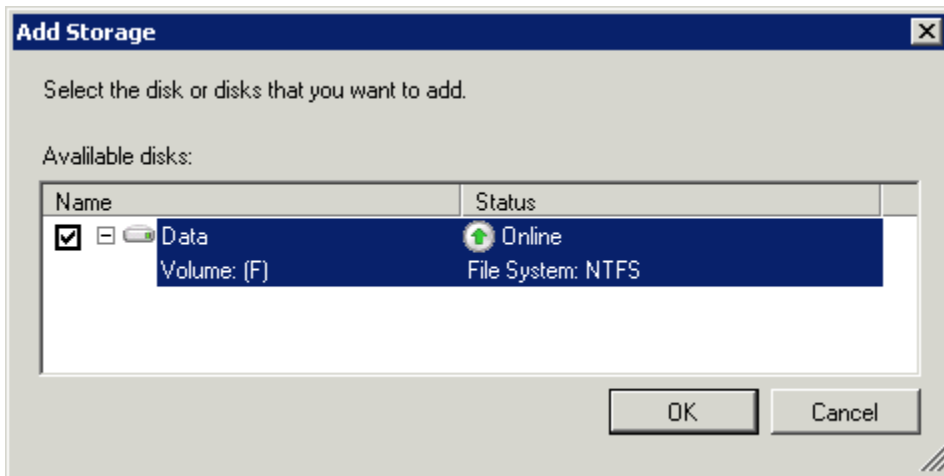

11. On the **Failover Cluster Management** window, in **Actions** pane, click **Add a resource**, and then select **Generic Service**.

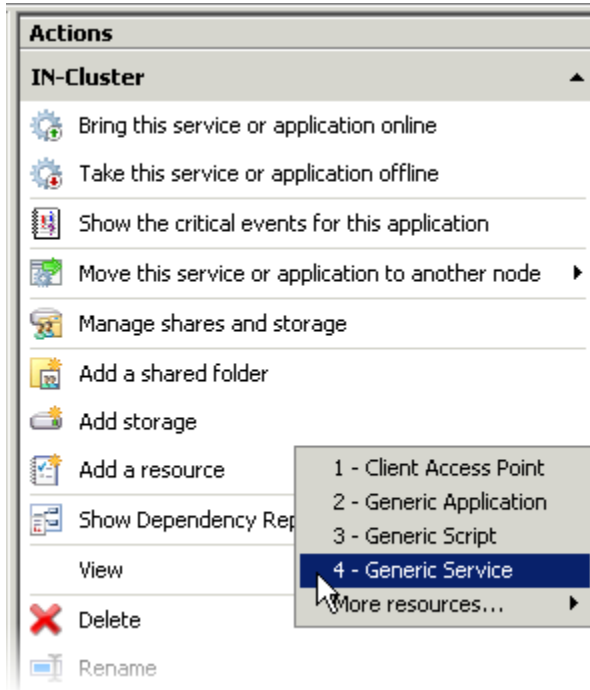

12. Select the service you want to add to the failover cluster and then click **Next**. Repeat the preceding step and this step to set up resources for each of the following embedded Perceptive Content Agents:

- Alarm Agent
- Batch Agent
- External Messaging Agent
- File System Agent
- Import Agent
- Job Agent
- Message Queuing Agent
- Monitor Agent
- Notification Agent (6.5 or higher)
- Retention Agent, (6.5 or higher)
- Perceptive Content Server
- Task Agent
- Workflow Agent

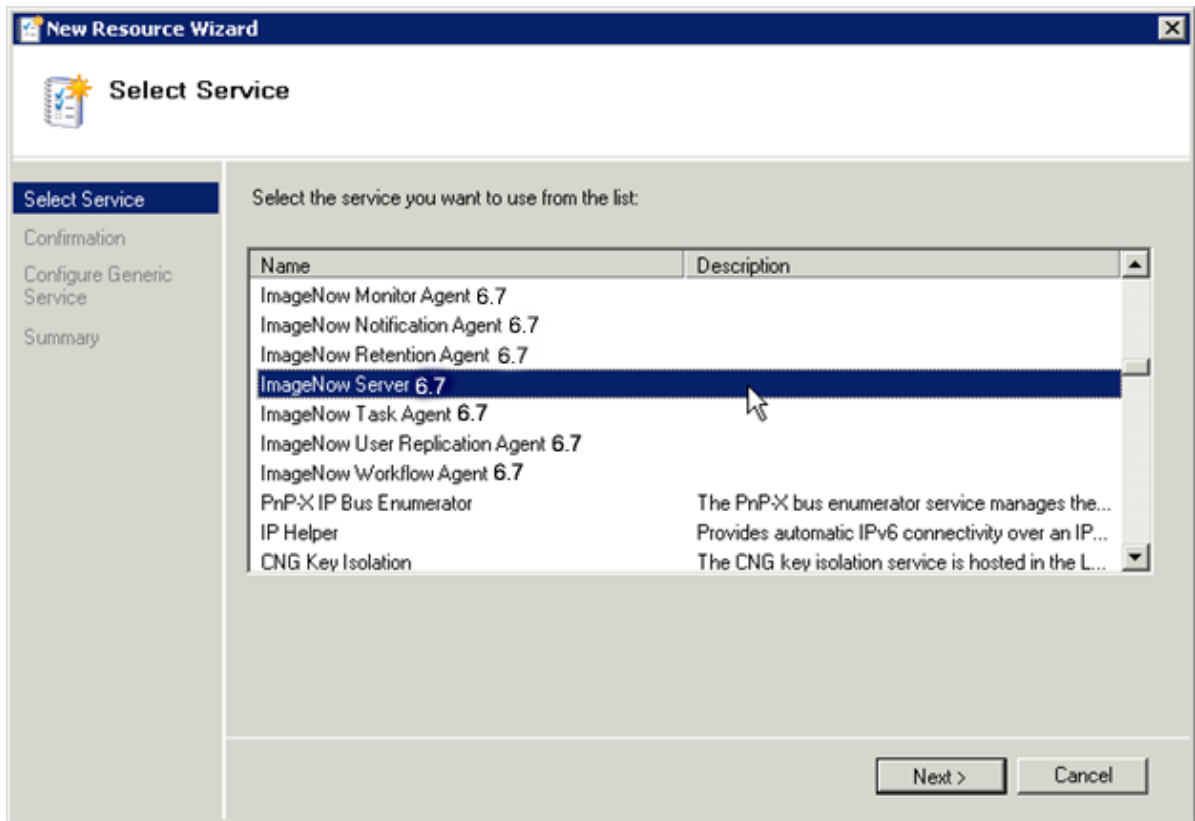

13. After adding the cluster group, you must add the resources required for Perceptive Content to the cluster. On the **Failover Cluster Management** window, in the **Actions** pane, click **Add a resource** and then select **Generic Application**.

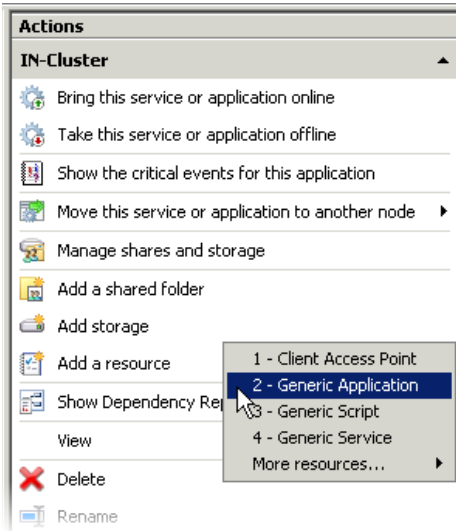

14. In the **New Resource** wizard, on the **Generic Application Settings** screen, specify the executable for the command line, specify the location of the **failover.bat** file for the parameters.
15. Click **Next**, then **Next**, and then **Finish**.

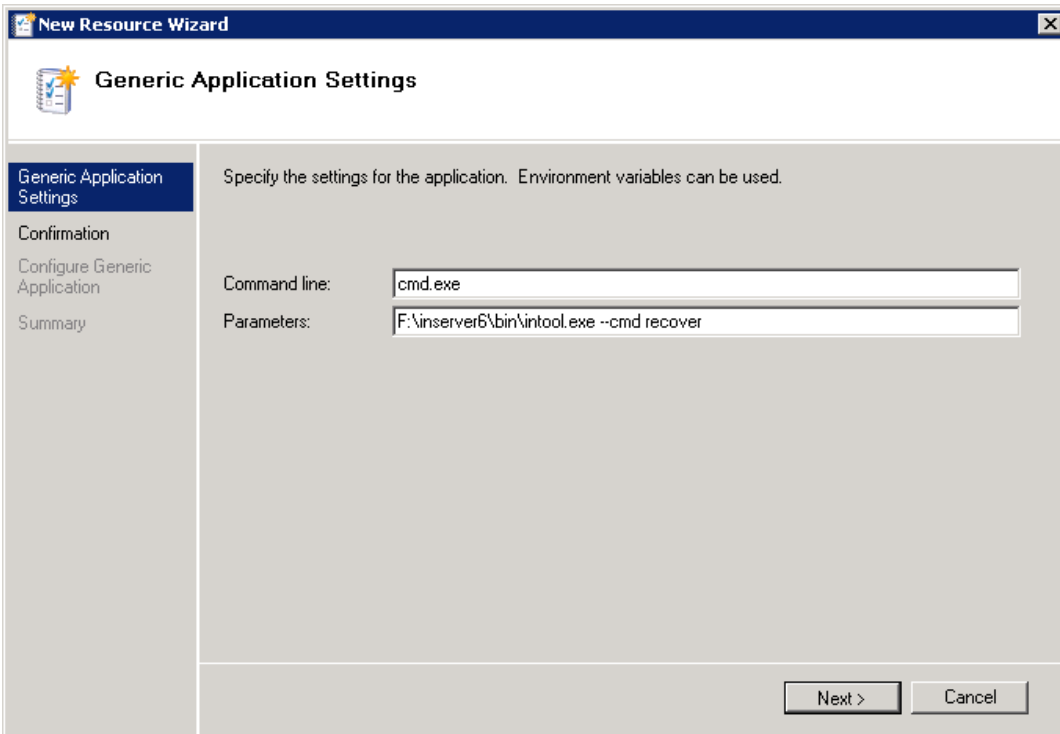

16. Right click the first resource, then click **Properties**.
17. In the **Properties** dialog, on the **Dependencies** tab, set up the dependencies according to the following table, which contains information you need to provide when you set up the resources, including the Virtual IP, documented in the previous steps. Set up the dependencies for each resource. In this case study, there are 12 mandatory resources to set up, with additional resources required for any external agent you run local to the Perceptive Content Server. The required settings for each of the resources appear in the following table.
18. For each resource, make sure that you set the **Possible Owners** to both the primary and the standby nodes.

Note Specific product version numbers are omitted from this table because it spans several product versions. On your system, the Resource Name and Parameters for Perceptive Content Server and its agents are followed by your specific version number.

In this case study, for ImageNow services and agent services, the restart parameter is set to **No** so that the Administrator can manually review the situation if a service fails and determine whether a failover is appropriate.

	Resource Name	Description	Resource Type	Restart?	Dependencies
1	Virtual IP	The cluster IP address	IP Address	No	None
2	IN-Cluster-V	The name of the cluster.	Network Name	Yes	Virtual IP
3	Disk F:	The failover drive associated with the cluster.	Physical Disk	Yes	Virtual IP IN-Cluster-V
4	IN-Server-Switch	Switch to reset Perceptive Content Server state. Note The Command line is cmd.exe, and the Parameter is F:\inserver\bin\intool.exe --cmd recover	Generic Application	No	Virtual IP IN-Cluster-V Disk F:
5	Perceptive Content Server	The Perceptive Content Server service.	Generic Service	No	Virtual IP IN-Cluster-V Disk F: IN-Server-Switch
6	Alarm Agent	The Alarm Agent service required by Perceptive Content.	Generic Service	No	Perceptive Content Server
7	Batch Agent	The Batch Agent service required by Perceptive Content.	Generic Service	No	Perceptive Content Server
8	Import Agent	The Import Agent service required by Perceptive Content.	Generic Service	No	Perceptive Content Server
9	Job Agent	The Job Agent service required by Perceptive Content.	Generic Service	No	Perceptive Content Server
10	Message Queuing Agent	The Message Queuing Agent service required by Perceptive Content.	Generic Service	No	Perceptive Content Server
11	Workflow Agent	The Workflow Agent service required by Perceptive Content.	Generic Service	No	Perceptive Content Server

	Resource Name	Description	Resource Type	Restart?	Dependencies
12	Any external Agent you have licensed, such as Content Server.		Generic Service	Yes, but do not affect the group.	Perceptive Content Server

Test the cluster resources

After adding the resources and setting the dependencies, you test the cluster by using the Move Group command to move the resource group from one node to the other using the following procedure.

To test an assisted failover

1. **Open Failover Cluster Management** and make sure that **IMG00** is the active node.
2. In the left pane, right-click the cluster you created (IN-Cluster in the example), select **Move this service or application to another node**, and select **Move to node <nodename>**. The view refreshes to show the transfer of the cluster from **IMG00** to **IMG01**.
3. With **IMG01** as the active node, repeat the previous step. The window refreshes to show the transfer of the cluster from **IMG01** back to **IMG00**.

During this test, all resources should successfully move from one node to the other. If any resources fail, open the resource and verify the settings against the dependency table. After testing an assisted failover, you can test other failover scenarios by restarting or shutting down the active node.

Case Study 2: Perceptive Content in a Microsoft Cluster Server 2003

The following case study provides a specific example of setting up Perceptive Content on a Microsoft Server Cluster. This case study is based on a two-node cluster. In this cluster, when one node is active, the other node is passive.

Create the server cluster

This case study depicts the Perceptive Content Server in a two-node cluster with a quorum drive and a shared drive (F:). In Cluster Server, the quorum drive provides a means to determine which server runs which processes and the state in which the servers and resources run. Perceptive Content Server runs on an active-passive cluster. The database runs on a separate server or SAN. When you configure the Perceptive Content Clients for the Perceptive Content Server, make sure that they point to the virtual IP address or name that you've set up to address the cluster.

The following table contains the recommended Cluster Server configuration from Microsoft. The clustering environment for this case study uses the following recommendations. For more information about these recommendations and more complete recommendations for geographically disbursed clusters, refer to the Microsoft website.

Type	Recommendations
Software	The Windows 2003 Computer Cluster Pack must be installed on a supported operating system. Make sure the supported operating systems are identical for both nodes. Supported operating systems include: <ul style="list-style-type: none"> Windows Server 2003 Datacenter Edition Windows Server 2003 Enterprise Edition
Hardware	Review and follow the Microsoft Hardware Compatibility List (HCL). Recommend using identical hardware on each node. All nodes require at least one NIC.
Network	The nodes of a cluster must belong to a single domain. The network should support Network Name Resolution (DNS). The nodes of the cluster should have domain membership and static IP addresses.
Shared Disks	SCSI or Fiber Channel NTFS with more than 500 MB

Install the Perceptive Content database and Perceptive Content Server

In this case study, the primary node is named IN-Primary and the standby node is named IN-Standby. The shared drive is set to F:, and this drive is only available to the active node.

By default, Perceptive Content Server is configured to install on C:\inserver on both nodes. This example uses the F: drive on both nodes. After verifying that IN-Primary is active, install Perceptive Content Server. During the installation, in the Destination Folder page, make sure you specify the virtual drive (F:) as the Destination directory. Then, fail over to the secondary node. Install Perceptive Content on this node, making sure that the same virtual drive (F:) is also the Destination directory. You add the `node.qualified.licenses = TRUE` setting to the `inow.ini` file in the `\inserver\etc` directory on each node.

Configure the cluster resources

In a Cluster Server, Microsoft recommends that you create a new resource group for each failover application. This section describes how to add the Perceptive Content resource group and then set up the resources for that group.

Add the Perceptive Content resource group

The following procedure describes the steps to create the new resource group. In this example, the resource group is named Perceptive Content Cluster.

Add the Perceptive Content cluster

1. Open the **Cluster Administrator**, right-click **Groups**, and then select **New**.
2. In the **New Group** page, in **Name**, type a name for the cluster, such as **Perceptive Content Cluster**, and then add a description for the cluster group.

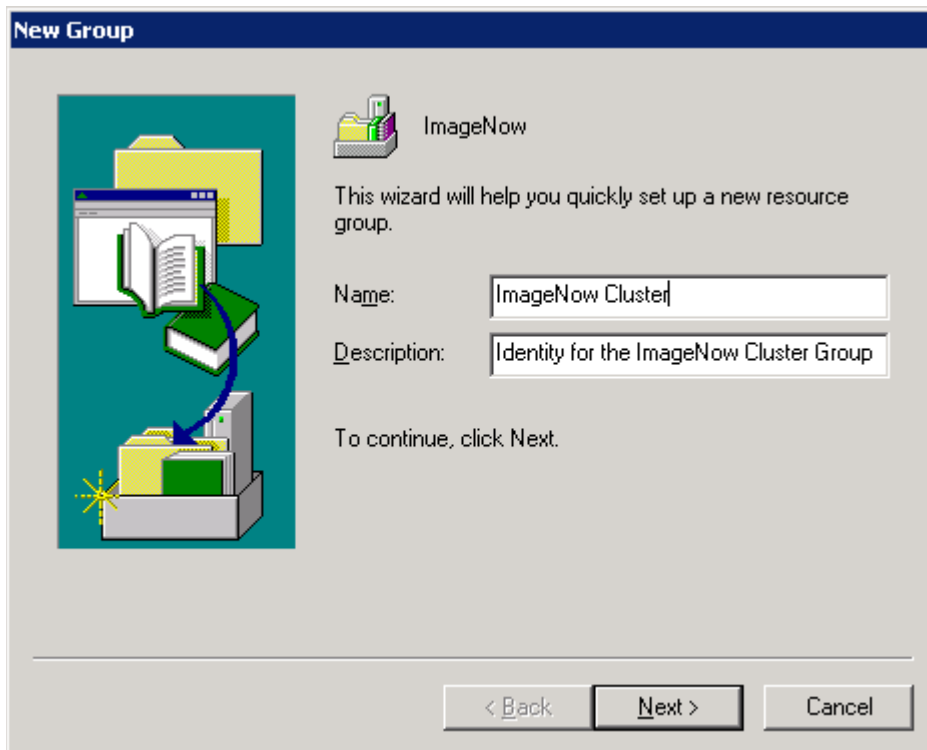

3. Click **Next**.
4. In the **Preferred Owners** page, select the primary node, SHIFT-click and select the standby node, then click **Add**.

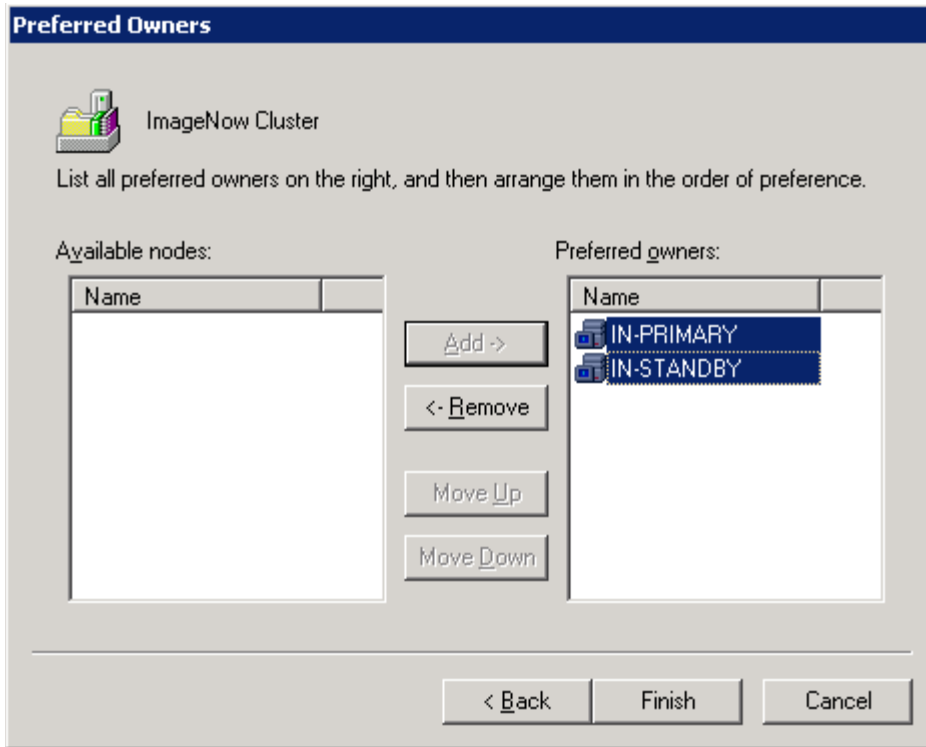

5. Click **Finish**. The new cluster group, named Perceptive Content Cluster in this example, appears under Groups as shown in the following figure.

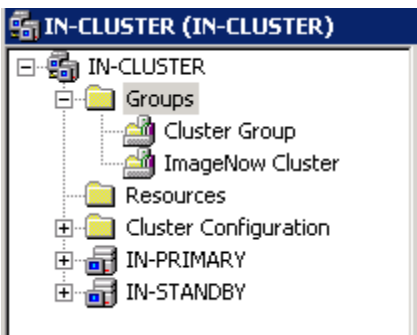

Set up resources for the Perceptive Content resource group

After adding the cluster group, in Cluster Administrator, you must add the resources required for Perceptive Content to the cluster in the following order:

1. Add an IP Address resource for the Virtual IP.
2. Add a Network Name resource as a computer name for the Virtual IP.
3. Add a Physical Disk resource as the shared drive where the Perceptive Content and license files reside.
4. Add a Generic Application as the Perceptive Content Server Switch to switch the active server.
5. Add a Generic Service resource as the Perceptive Content Server.
6. Add a Generic Service resource for each of the embedded Agents (Alarm Agent, Batch Agent, Import Agent, Job Agent, Message Queuing Agent, and Workflow Agent) and any additional agents for which you have licenses.

Add a resource in Cluster Administrator

You must be on the active node to run Cluster Administrator. The following steps create the first resource you need for your Perceptive Content Cluster. After performing these steps, use the same procedure for the additional resources.

1. Open the **Windows Cluster Administrator**.
2. In the left pane, open **Groups**, right-click the **Perceptive Content Cluster** group, select **New**, and then click **Resource**.
3. In the **New Resource** page, type the following:
 1. In **Name**, type **Perceptive Content Virtual IP**.
 2. In **Description**, type **This is the virtual IP for the cluster**.
 3. In **Resource** type, select **IP Address**.

4. In **Group**, select the name of your cluster group.

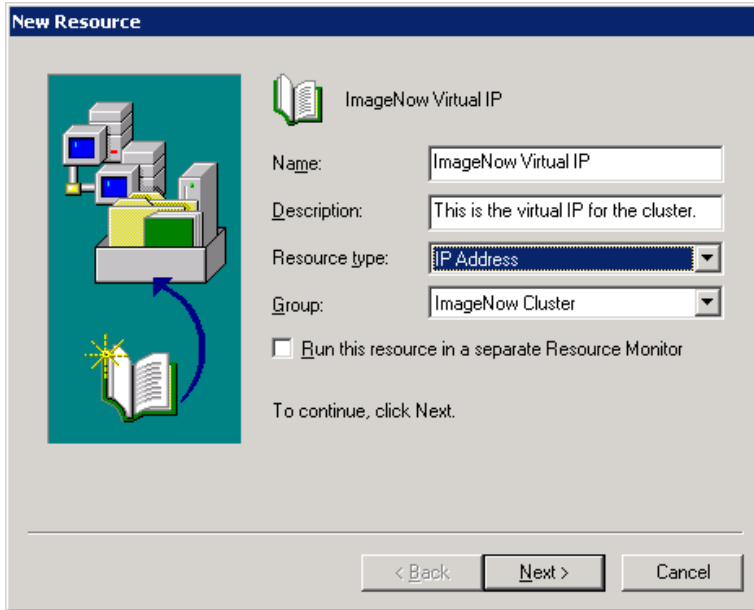

4. Click **Next**.
5. In the **Possible Owners** page, make sure that both Perceptive Content server nodes are on the right pane under **Possible owners**.

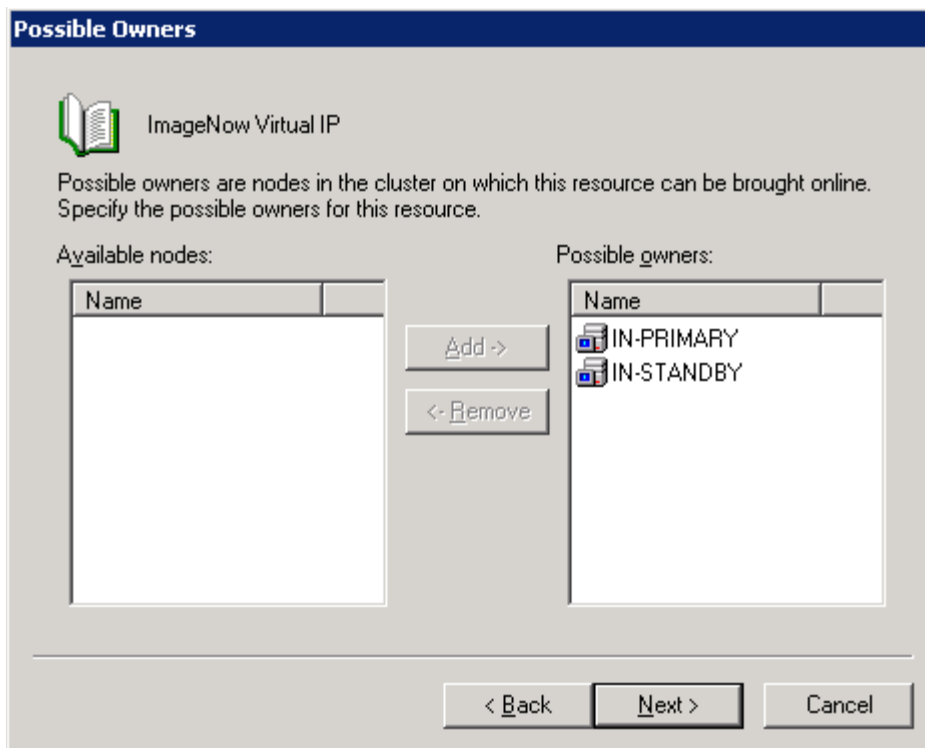

6. Click **Next**.
7. In the **Dependencies** page, there are no dependencies for this resource, so click **Next**.
8. In the **TCP/IP Address Parameters** page, in **Address**, type the IP address, type the Subnet mask, and then in **Network**, select **LAN**.

The screenshot shows a dialog box titled "TCP/IP Address Parameters" for "ImageNow Virtual IP". It contains the following fields and options:

- Address:** 172 . 255 . 66 . 1
- Subnet mask:** 255 . 255 . 252 . 0
- Network:** LAN (selected from a dropdown menu)
- Enable NetBIOS for this address**

At the bottom of the dialog box are three buttons: "< Back", "Finish", and "Cancel".

9. Click **Finish**.
10. Add the remaining resources listed in the following table. The table contains information you need to provide when you set up the resources, including the ImageNow Virtual IP, documented in the previous steps. There are 12 mandatory resources to set up, with additional resources required for any external agent you run local to the Perceptive Content Server. The required settings for each of the resources appear in the following table.
11. For each resource, set the **Possible Owners** to both the primary and the standby nodes.

Note Specific product version numbers are omitted from this table because it spans several product versions. On your system, the Resource Name and Parameters for Perceptive Content Server and its agents are followed by your specific version number.

In this case study, for ImageNow services and agent services, the restart parameter is set to No so that the Administrator can manually review the situation if a service fails and determine whether a failover is appropriate.

	Resource Name	Description	Resource Type	Restart?	Dependencies	Parameters
1	Virtual IP	The cluster IP address	IP Address	No	None	The IP Address
2	IN-Cluster-V	The name of the cluster.	Network Name	Yes	Virtual IP	The name of the cluster (IN-Cluster-V in this example.)
3	Disk F:	The failover drive associated with the cluster.	Physical Disk	Yes	Virtual IP IN-Cluster-V	
4	IN-Server-Switch	Switch to reset Perceptive Content Server state.	Generic Application	No	Virtual IP IN-Cluster-V Disk F:	<u>Parameter:</u> intool.exe --cmd recover <u>Current Directory:</u> F:\inserver\bin
The remaining resources are the ImageNow services. The service names must match the service names shown in Windows.						
5	Perceptive Content Server	The Perceptive Content Server service.	Generic Service	No	Virtual IP IN-Cluster-V F: IN-Server-Switch	<u>Service Name:</u> Perceptive Content Server <u>Start Parameter:</u> net start Perceptive Content Server
6	Alarm Agent	The Alarm Agent service required by Perceptive Content.	Generic Service	No	Perceptive Content Server	<u>Service Name:</u> Alarm Agent <u>Start Parameter:</u> net start Alarm Agent

	Resource Name	Description	Resource Type	Restart?	Dependencies	Parameters
7	Batch Agent	The Batch Agent service required by Perceptive Content.	Generic Service	No	Perceptive Content Server	<u>Service Name:</u> Batch Agent <u>Start Parameter:</u> net start Batch Agent
8	Import Agent	The Import Agent service required by Perceptive Content.	Generic Service	No	Perceptive Content Server	<u>Service Name:</u> Import Agent <u>Start Parameter:</u> net start Perceptive Content Import Agent
9	Job Agent	The Job Agent service required by Perceptive Content.	Generic Service	No	Perceptive Content Server	<u>Service Name:</u> Job Agent <u>Start Parameter:</u> net start Perceptive Content Job Agent
10	Message Queuing Agent	The Message Queuing Agent service required by Perceptive Content.	Generic Service	No	Perceptive Content Server	<u>Service Name:</u> Message Queuing Agent <u>Start Parameter:</u> net start Perceptive Content Message Queuing Agent
11	Workflow Agent	The Workflow Agent service required by Perceptive Content.	Generic Service	No	Perceptive Content Server	<u>Service Name:</u> Workflow Agent <u>Start Parameter:</u> met start Perceptive Content Workflow Agent

	Resource Name	Description	Resource Type	Restart?	Dependencies	Parameters
12	Any external Agent you have licensed, such as Content Server .		Generic Service	Yes, but do not affect the group.	Perceptive Content Server	<u>Service Name:</u> Perceptive Content <the service name> <u>Start Parameter:</u> met start Perceptive Content <the service name>

Test the cluster resources

After adding the resources and setting the dependencies, test the cluster by using the Move Group command to move the resource group from one node to the other using the following procedure.

Test an assisted failover

1. Open the **Windows Cluster Administrator** and make sure that **IN-Primary** is the active node.
2. In **Cluster Administrator**, right-click the **Perceptive Content Group** and select **Move Group**. The window refreshes to show the transfer of the cluster from IN-Primary to IN-Standby.
3. With IN-Standby as the active node, repeat the previous step. The window refreshes to show the transfer of the cluster from IN-Standby back to IN-Primary.

During this test, all resources should successfully move from one node to the other. If any resources fail, open the resource and verify the settings against the dependency table. After testing an assisted failover, you can test other failover scenarios by restarting or shutting down the active node.

Index

cluster interaction	4	set up resources.....	26
cluster resources	6, 31	test cluster resources	31
cluster setup	6	Microsoft Server Cluster 2008	
configure cluster	9	add Perceptive Content cluster	12
create server cluster.....	7	add Perceptive Content resource group	12
failover	9	configure cluster resources	12
failover requirements.....	5	create server cluster.....	11
install Perceptive Content	8	install Perceptive Content Server and database	11
Microsoft Server Cluster		test cluster resources	22
2003.....	23	Perceptive Content cluster.....	24
2008.....	11	Perceptive Content resource group	12, 24, 26
Microsoft Server Cluster 2003	23	requirements	4
add a resource in Cluster Administrator	26	SAN.....	4
add Perceptive Content cluster	24	server cluster	7
add Perceptive Content resource group.....	24	shared storage	4
configure cluster resources	24	testing	9, 22, 31
create server cluster	23		
Install Perceptive Content Server and database	24		